

JBC

www.jbctools.com

INSTRUCTION MANUAL



B·IRON 210

Battery-Powered Soldering Station

This manual corresponds to the following references:

BIS-5A*

**according to purchased station model, suitable for:
120V - N. America / Taiwan
230V - India / Europe / United Kingdom*

Packing List

The following items are included:



B115 / B210 Charging Base 1 unit
Ref. 0032434



Portable Display 7" for B·IRON 1 unit
Ref. PDS-B



Precision Handle for B·IRON 1 unit
Ref. B210-C
Includes Cap for B115/B210 Handles (ref. 0031596)



C210 Cartridge 1 unit
Ref. C210001 (tip \varnothing 0.3 mm)

** Included according to purchased reference.*



Holder for Portable Display 5" to 7" ... 1 unit
Ref. 0030723
Includes fixing knob



USB Cable (USB A to Micro USB) 1 unit
Ref. 0028092



Brass Wool for B-IRON 1 unit
Ref. CL0300
Already assembled in the charging base



Power Cord * 1 unit
Ref. 0027380 *120V - N. America / Taiwan*
0027381 *230V - India*
0027382 *230V - Europe*
0027378 *230V - United Kingdom*

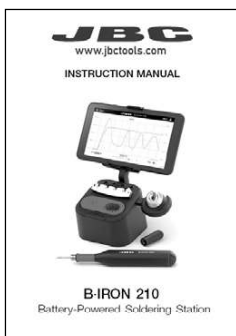

Manual 1 unit
Ref. 0030318

** Included according to purchased station model.*

 Please read this manual and its safety guidelines thoroughly before using the product.

Features & Connections



Features and Connections

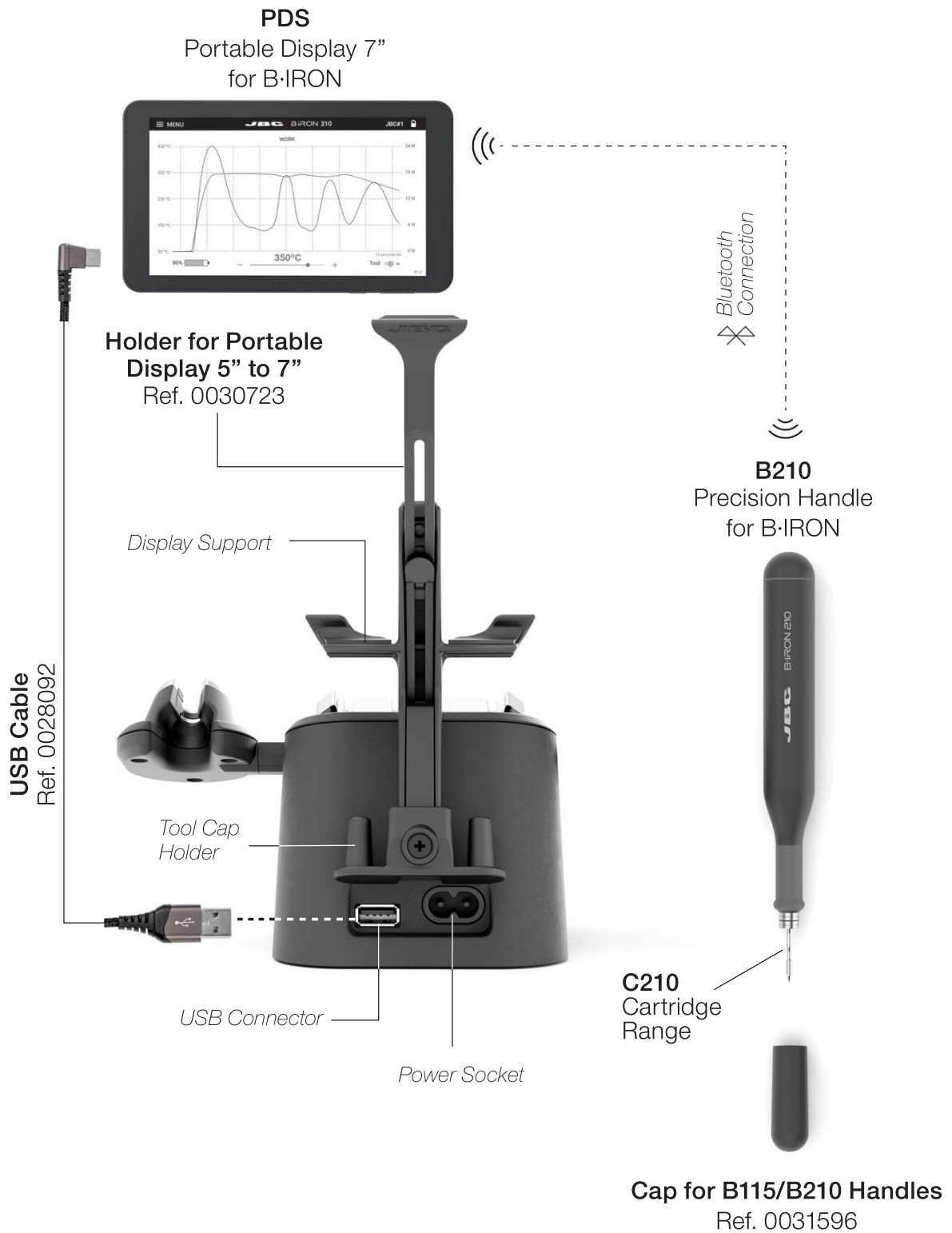

Quick Start

1. Display Holder Assembling

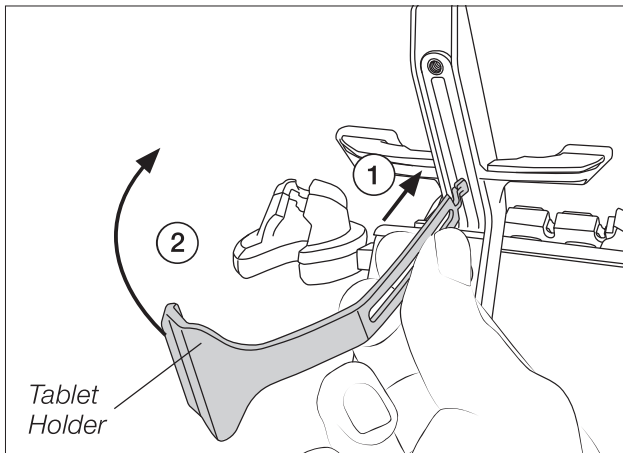

Insert the thin end of the display holder into the upper area of the rear rail of the charging base (1). Then carefully rotate the display holder 90 degrees (2) until it stands vertical.

2. Display Holder Setting

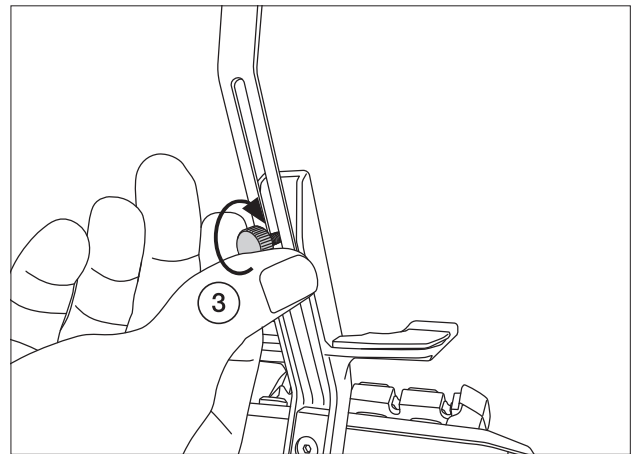

Insert the fixing knob (3) and tighten it just enough so that it stays in its place but the display holder can be moved.

3. Display Placing

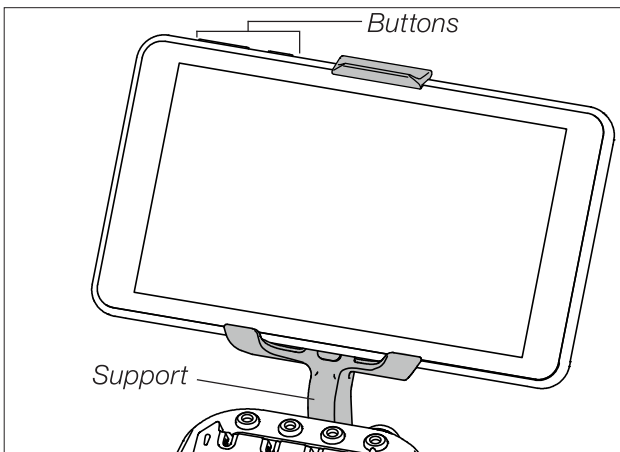

Place the display on the support with its buttons facing upwards and adjust the height of the display holder.

Once the display holder is at the right height, tighten the fixing knob completely to fix the display in place.

4. Base Connection / Display Connection

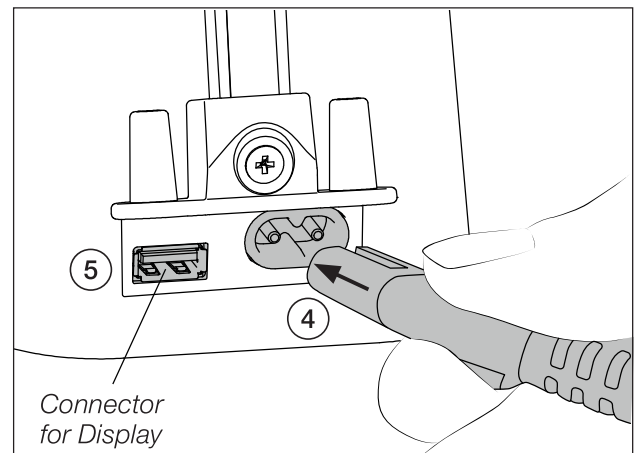

Connect the charging base to the mains (4).

If needed, the display can be connected to the USB port (5) with the provided USB cable to keep it charging while working.

5. Turning on the Portable Display

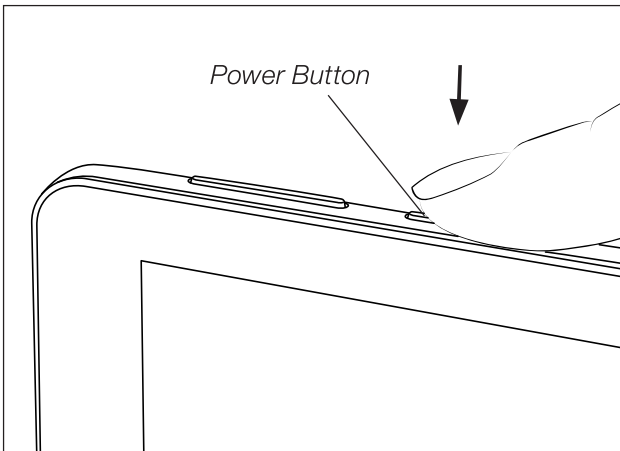

Turn on the display by holding down the power button and then open the B-IRON app*:



* **Note:** The app can also be downloaded to your own devices. To know how, see section “Installing and Updating the B-IRON App”.

6. Tool Holder Angle Adjustment

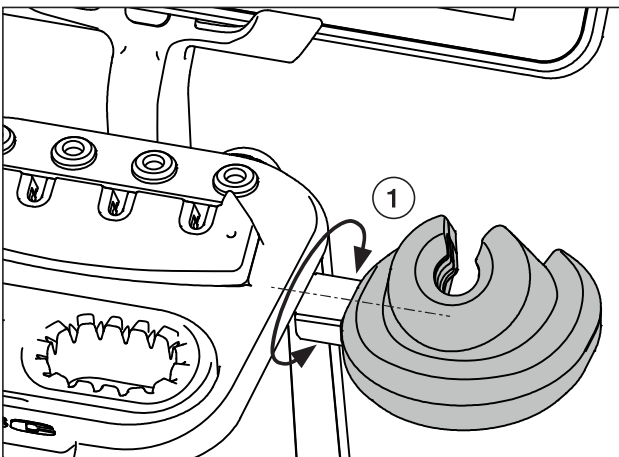

Adjust the tool holder angle by simply rotating it forward or backward (1) to the desired working position (2). Tool holders have 7 different positions, each varying by an angle of 10 degrees.

 Do not rotate the tool holder with a tool resting on it.

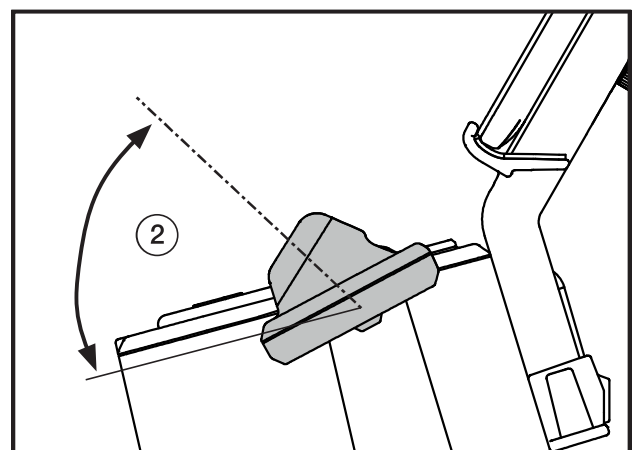
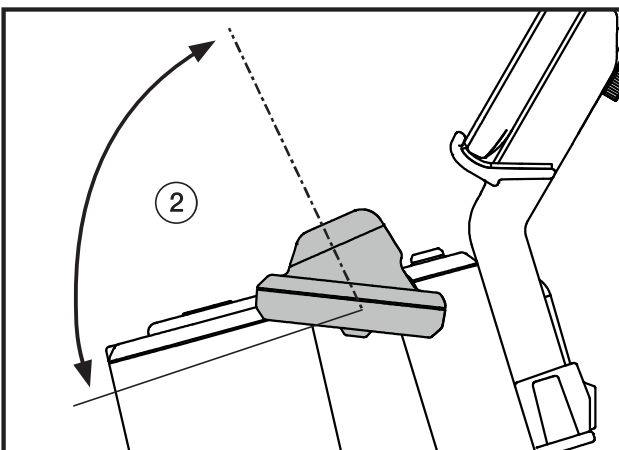

7. Cartridge Insertion and Charging

Inserting

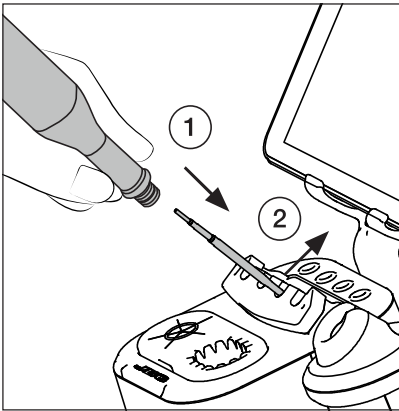

Place the tool over a cartridge and press the tool down to insert the cartridge (1). To release the tool with the cartridge from the extractor, lift the tool upward (2).

Fixing

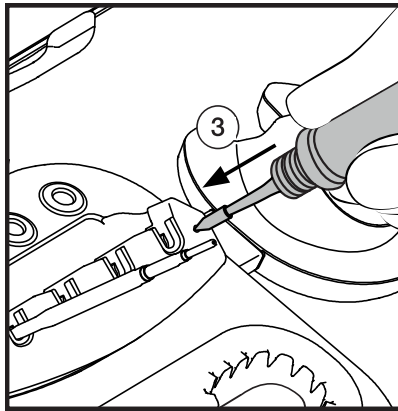

Make sure that the cartridge is appropriately inserted* into the tool by gently pressing the tip against the holes on the sides of the cartridge exchanger (3).

***Important:** Cartridges must be inserted up to the mark for a proper connection.



Charging

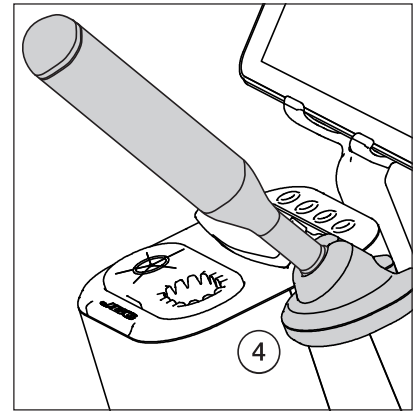

Place the tool on the tool holder (4) to charge it. A beep will sound to confirm that the tool is properly placed and charging.

The sound can be turned up, down or off using the buttons on the display.

⚠ Note: Charge the tool completely before using it for the first time. It will take approx. 60 min for B210, approx. 30 min for B115 and approx 40 min for BP115.

For more information on how to change cartridges and the use of the cartridge exchanger, see section “Cartridge Exchanger and Cartridge Holder”.

Compatible Cartridges

B210 Handle works with C210 Cartridges. Find the model that best suits your soldering needs at www.jbctools.com

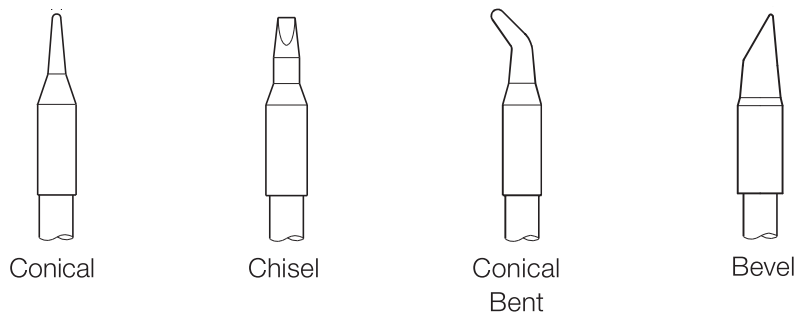

8. Tool Selection

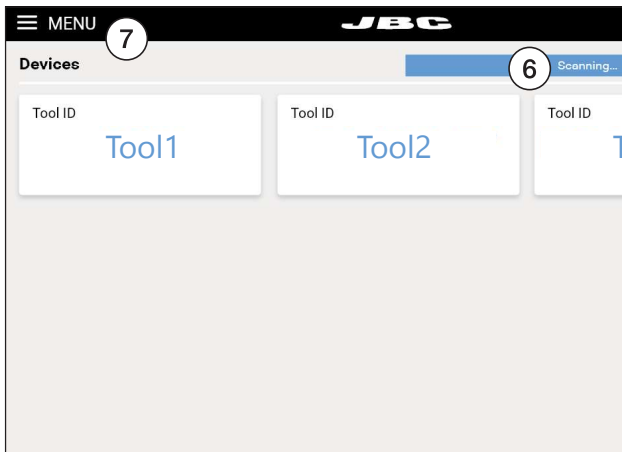

Select the tool from the device list. If the tool is not displayed on screen, make sure that the cap is off and the tool has some battery. Try scanning again by tapping *Scan* (6) on the display.

To add a second tool to the station once the first one is connected, go to the main menu (7) and tap *Add device*. Select your second tool from the device list.

Status Lightband



The status lightband indicates as follows the tool status:

green	working/soldering tool fully charged
green blinking	charging
alternating red/green blinking	low battery, less than 20%
red blinking	no cartridge
blue blink every few seconds	the cap is on and the tool is disconnected
no color	power off

Tool Cap and Tool Cap Holder



Thanks to the cap for B210 and B115 handles, tools can be safely transported even with a cartridge inserted.

When the cap is placed onto the tool, the cartridge stops heating immediately, data transfer is cut off and the tool is disconnected from the station. It turns off completely after 10 minutes of inactivity. This allows a greater saving of the tool's battery.

The stand has a holder for two tool caps on the back. This component can be detached by loosening and removing the screw between the two holders (1).

While the tool is being used, the cap can be stored on the tool cap holder.

Operation

The JBC Most Efficient Soldering System

This revolutionary technology can recover tip temperature extremely quickly. This allows the user to work at a lower temperature.

Work

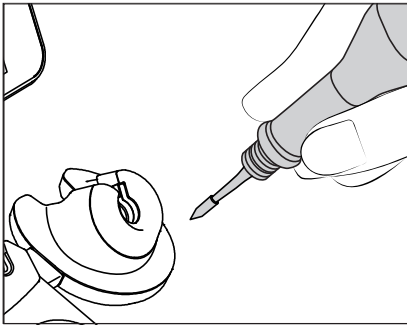

When the tool is lifted from the tool holder, the tip of the assembled cartridge will heat up to the selected working temperature.

Charge Mode

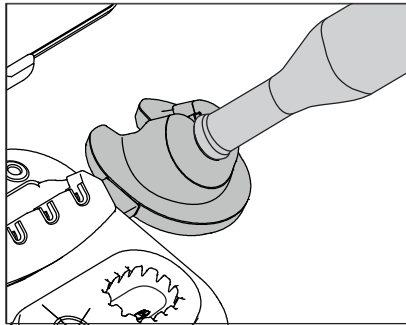

While the tool remains on the tool holder, it charges and the tip will gradually cool down to room temperature.

Sleep Mode

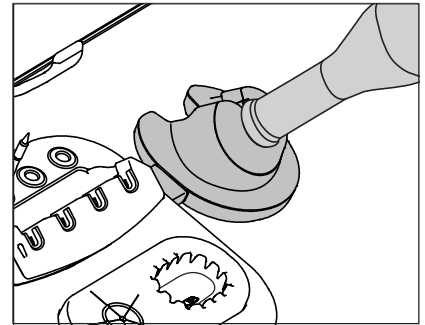

If Sleep Mode is activated (see section “Settings”), upon placing the tool on its holder, besides charging it enters Sleep Mode. The tip temperature will drop down and remain at Sleep temperature.

Hibernation Mode

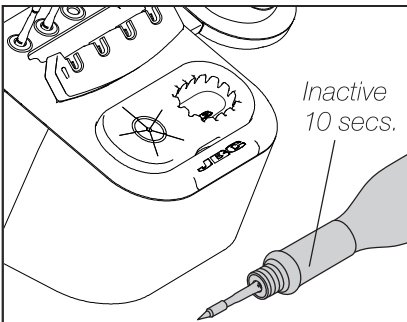

When the tool is away from the tool holder and remains inactive (no movement for at least 10 seconds), the tool goes into Hibernation Mode and the tip temperature gradually cools down to room temperature.

Automatic Turn Off

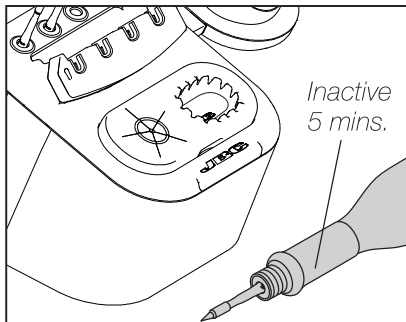

If the tool has been inactive for a longer period of time (at least 5 minutes), it automatically turns off.

Turning the Tool Back On

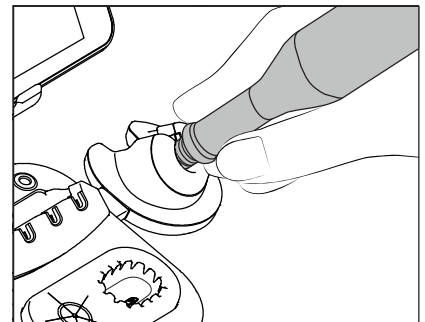

After automatically turning off, put the tool back on the tool holder to turn it on again.

Note: The tool can also be switched off/on manually. Tap the *Tool* power switch on the display (bottom right) to switch it off/on (if the tool is turned off, it will remain connected up to 5 minutes to the station but will not heat up the cartridge).

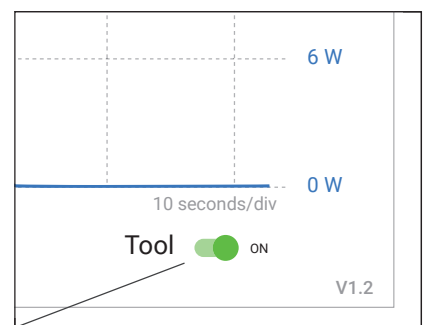

Tool Power Switch

Work Screen

The Work screen shows a graph of the tip temperature and power supplied to the tip updated in real time. It allows to modify the tool working temperature, check the battery status and turn on and off the tool in use.

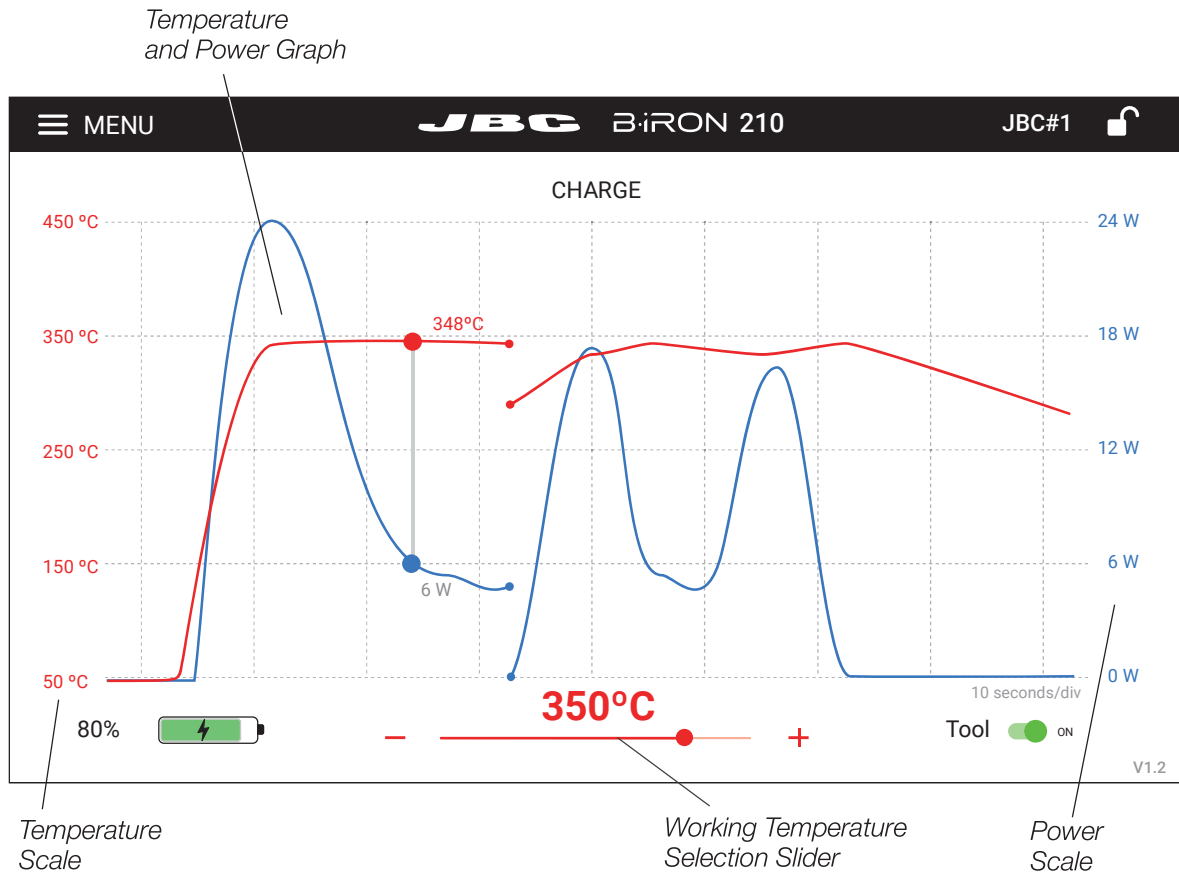

Graph and Automatic Data Display

The graph display of the temperature and supplied power starts automatically as soon as the tool is lifted from the charging base.

The graph display can be paused while working by tapping the screen on the graph area. While the automatic display is on hold, the temperature/power values can be checked at a certain point of the graph by tapping on the desired position on the display screen.

Note: Pausing the automatic display by tapping on the screen does not stop the tool from heating up, and the tip will remain at the selected working temperature.

The graph can be moved to the left and right by swiping the touch screen sideways with one finger.

Working Temperature Modification

The working temperature can be modified using the slider below the graph ($\pm 5^\circ\text{C}$ / $\pm 10^\circ\text{F}$).

Work Screen

Connected Tool and Tool Selector

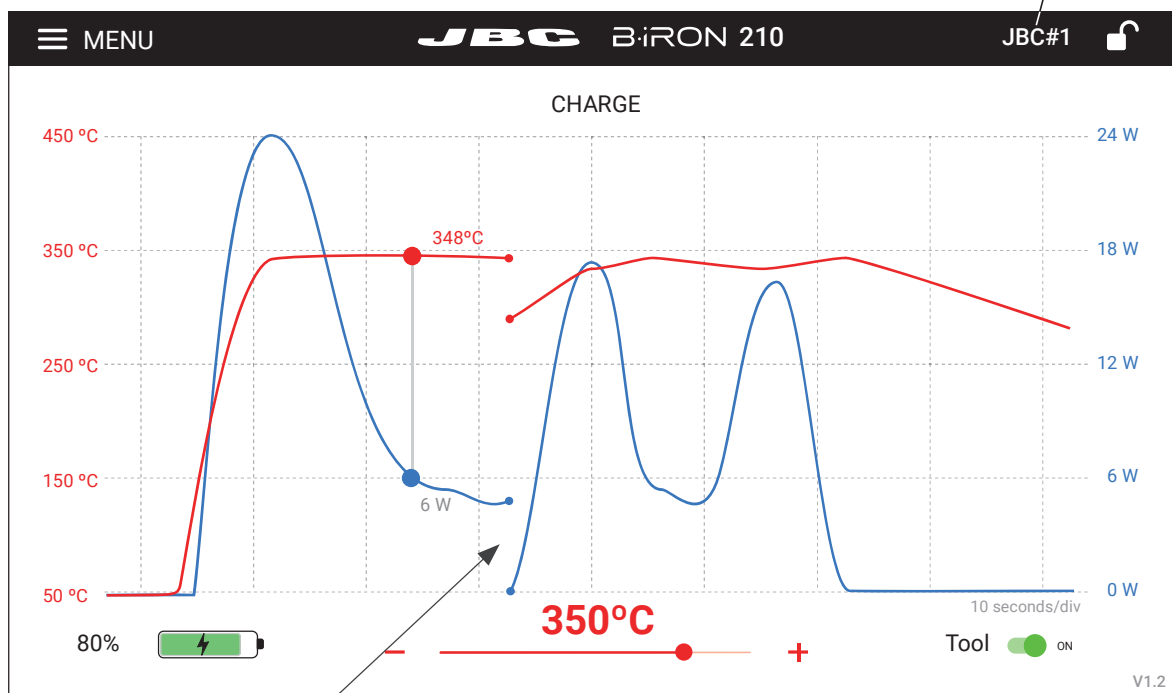

When the tool is not in use the graph stops recording

Stopping Data Display

When the tool is placed on the tool holder or when it enters Hibernation Mode, the data display stops.

The display starts again automatically when the tool is lifted from the tool holder and the graph is automatically displayed again at the point where the previous display stopped, leaving a small gap on the graph between the last registered value and the new starting point.

Working with Two Tools

When working with two tools, to switch between the two graphs, tap on the tool selector (upper-right corner of the display) and select the desired tool from the drop-down menu.

It is also possible to alternate both graphs by simply lifting one tool or the other from the tool holder. The display will automatically show the graph and information of the tool in use.

Note: All menu items are explained in detail starting at section “Menu”.

Cartridge Exchanger

The cartridge exchanger saves time and allows to change cartridges safely without switching the tool off.

1. Removing Cartridges

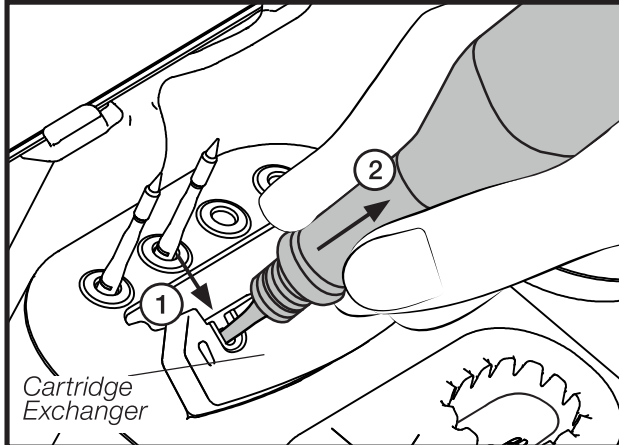

Place the cartridge exchanger over one of the slots of the cartridge exchanger and press down (1) until you hear a click. Then pull the handle out (2) to remove the cartridge.

2. Inserting Cartridges

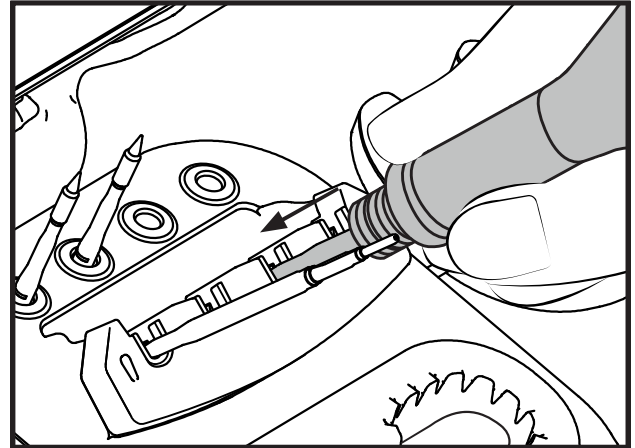

Place the handle over a cartridge and press the handle down to insert the cartridge.

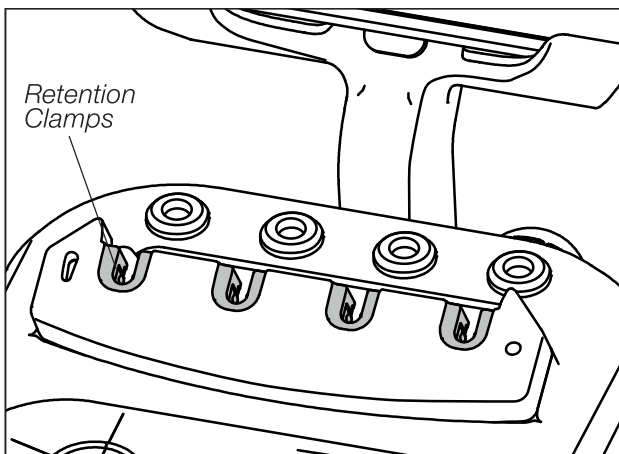

Cartridge Retention

Cartridges are held in place inside the cartridge exchanger thanks to the retention clamps, with the advantage that the cartridges do not fall into the exchanger and the cartridge tips are therefore protected. The cartridge exchanger of B-IRON stations works with C210 and C115 cartridges.

C210 Cartridge Retention Area

The holding area of C210 cartridges goes from the start of the tip until the cartridge begins to widen.



C115 Cartridge Retention Area

The holding area of C115 cartridges is delimited by the two rings before the tip.

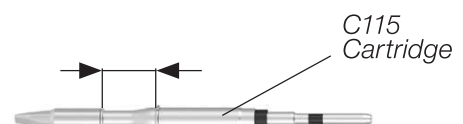

3. Fixing Cartridges

Depending on the shape of the tip, use the holes on the sides of the cartridge exchanger to properly adjust the cartridge.

Important: Push the cartridge in as far as it will go, making sure that it is firmly assembled*.

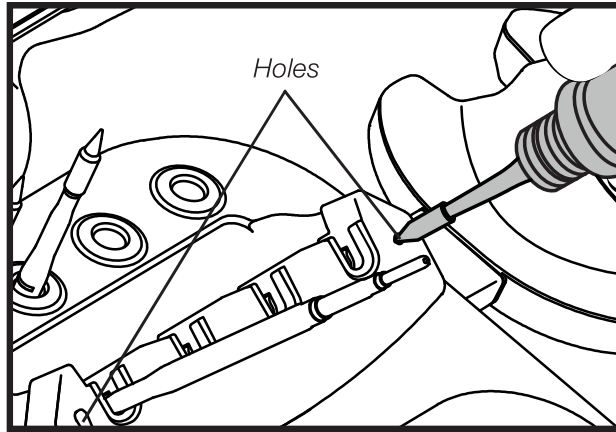

*Inserting C210 Cartridges

Push the cartridges inside the handle until the the reference mark is aligned with the edge of the handle.

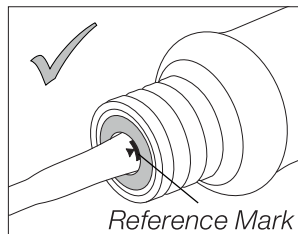
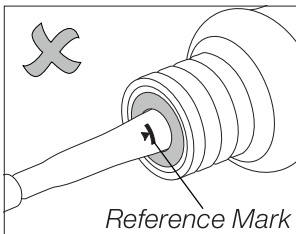

*Inserting C115 Cartridges

Push the cartridges inside the handle until the reference ring rests against the sealing plug.

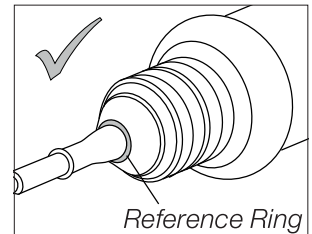
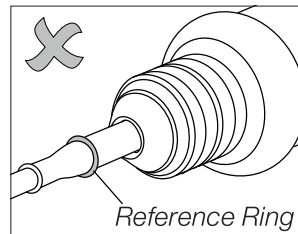

Cartridge Holder for C210 Cartridges

The cartridge holder (4x slots) is used to store cartridges. It allows to have different cartridges quickly at hand and it works with C210 Cartridges.

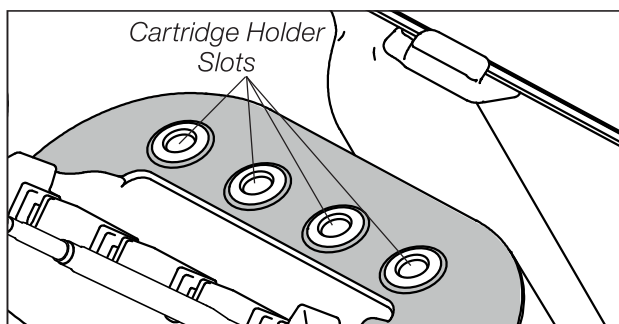

Cartridge Adapters for C115 Cartridges

Since C115 cartridges have a smaller diameter than C210 cartridges, adapters must be used to store them in the cartridge holder.

These adapters must simply be inserted from above into the slots of the cartridge holder.

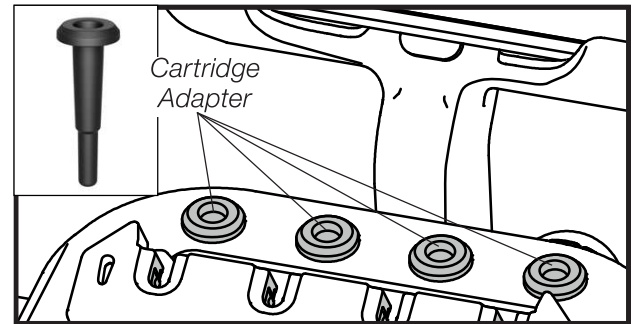

Tip Cleaner

Select the option that best suits your needs and improve the tip thermal transfer.



CL0300

Brass Wool for B·IRON

Very effective cleaning method. Leaves a small layer of solder on the tip preventing oxidation between cleaning and rewetting.

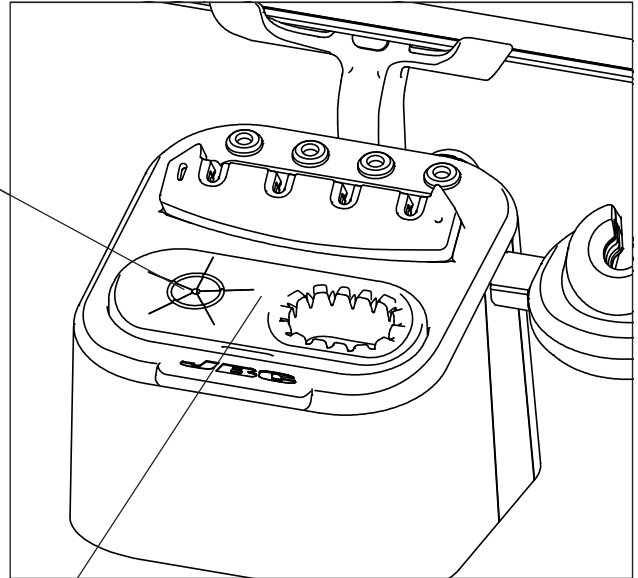
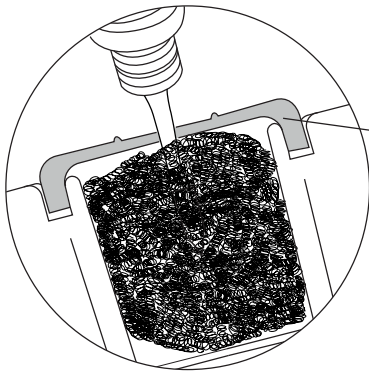

CL0301

Wiper for B·IRON Charging Base

CL0301 includes an antisplash area that prevents solder particles from splashing onto the working area, keeping the workplace clean.

It also includes a temperature-resistant wiper for removing excess solder by gently tapping or wiping the cartridge tip on it.

If the tip is very dirty, JBC recommends cleaning it first with the wiper to remove excess solder and then with the brass wool.

Wiper

Tapping

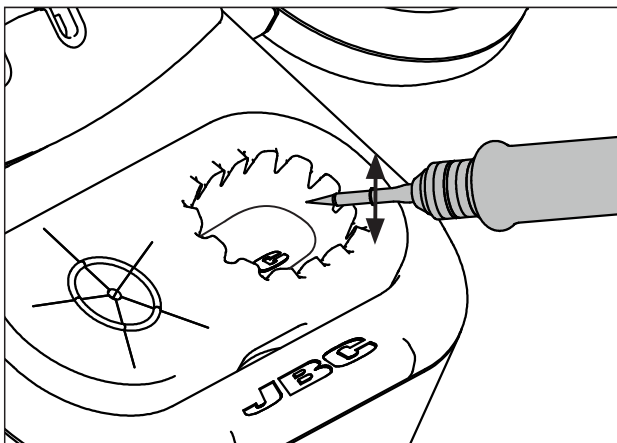

Tap gently to remove excess solder.

Wiping

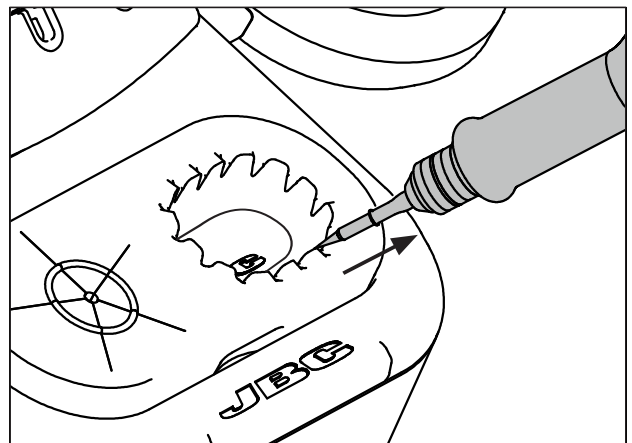

Use the slots to remove remaining particles.

Replacing Brass Wool

1. Lifting

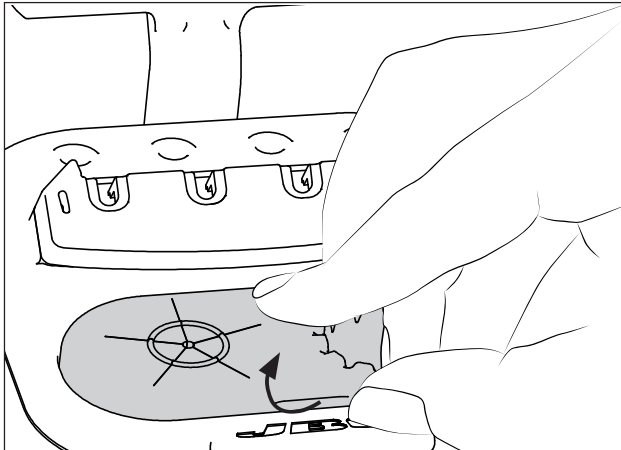

Lift the wiper by using the recess on the edge.

2. Replacing



Remove the wiper and replace the brass wool with a new one.

3. Reassembling

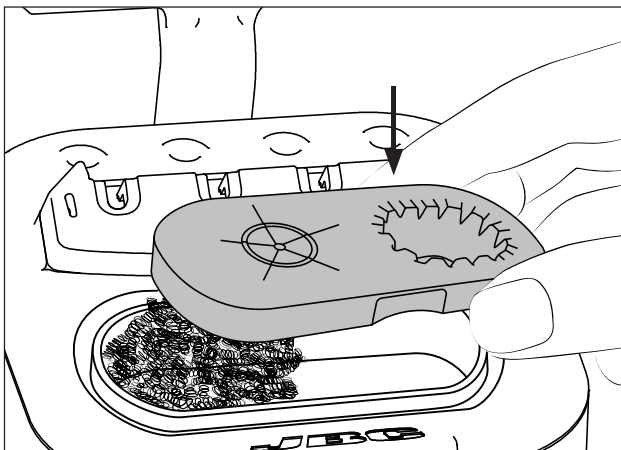

Assemble the new wiper onto the charging base. Make sure that the brass wool is on the far left and that there is space for the wiper on the right.

4. Pressing on

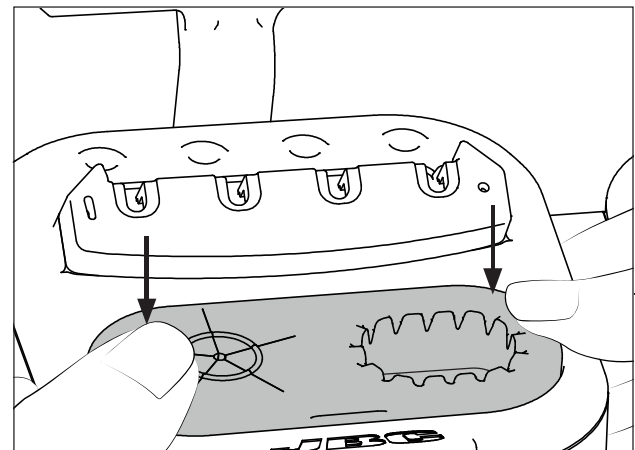

Press the wiper down. Make sure that the wiper membrane is correctly inserted all around.

Note: The brass wool and the wiper positions can be reversed by rotating the antispash membrane 180 degrees.

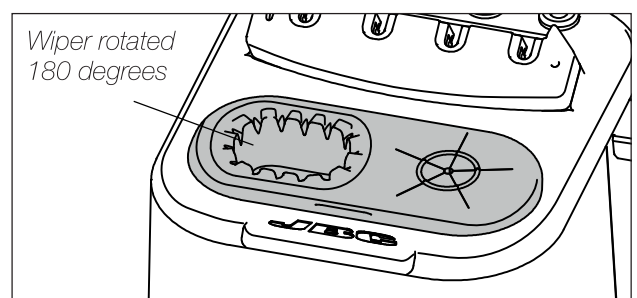
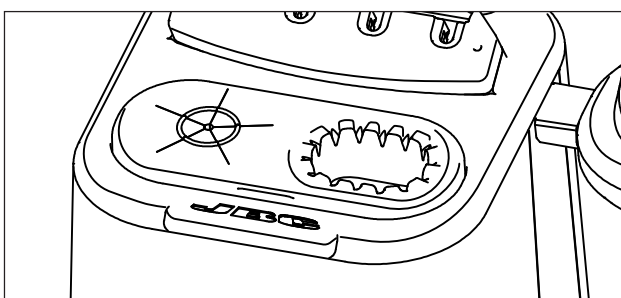

Replacing Grips

1. Cutting

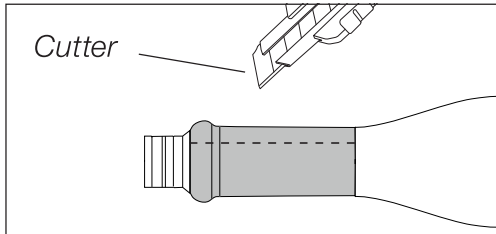

Make a length-ways cut on the worn grip.
⚠ Be careful not to damage the handle.

2. Removing

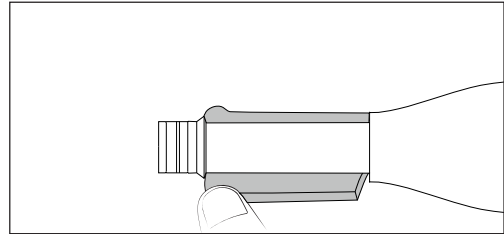

Remove the worn grip.

Assembling New Grips

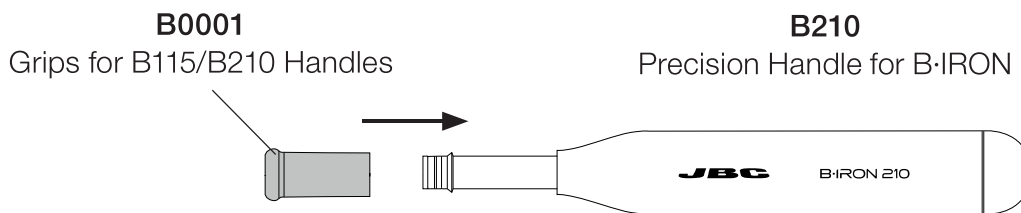

Firmly slide the grip onto the handle until it locks into place.

Replacing Sealing Plugs

The sealing plug prevents undesirable flux vapors or particles from entering the handle.

Note: Depending on your handle model, two sealing plug references are available.

⚠ Before replacing the sealing plug, disconnect the tool from the station and make sure the device is not hot.

Handle	Sealing Plug
B210	OB4000
B115	OB5000

OB4000 for B210 Handles

For B210 handles the usage of OB4000 sealing plug is highly recommended for intensive applications when soldering is exposed to FOD environments or for applications where the soldering iron works close to a vertical position.

1. Removing Sealing Plug

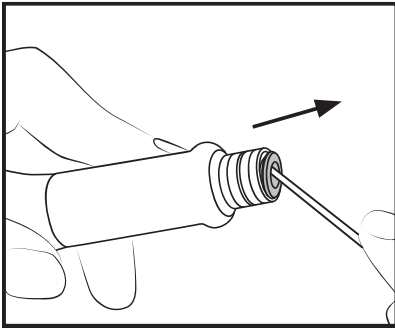

Introduce a small shaft or screwdriver, not deeper than 8 mm, lift and pull the sealing plug. Never use a cartridge to do this operation.

2. Mounting Position

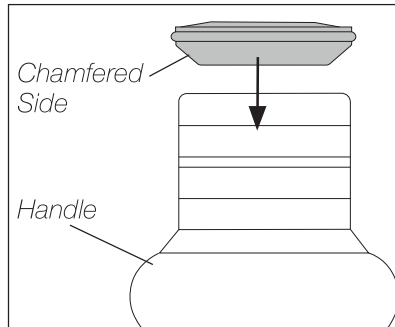

Note: The chamfered side has to be positioned towards the handle.

3. Inserting Sealing Plug

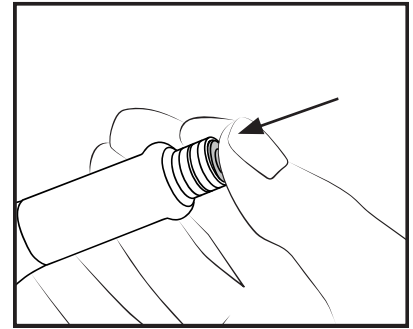

Push the sealing plug inside the handle until the sealing plug and handle edges are aligned.

Tool Holder Dissassembly and Replacement

Adjustable tool holders can be disassembled by loosening the screws (1) at the bottom of the charging stand and pulling downward from the side band (2).

⚠ Before sliding down the side band, hold the tool holder with your hand to prevent it from falling off.

Then, to install a new tool holder onto the charging base, place the tool holder at the top of the side rail and slide back the side band over it until it is secured in place. Finally tighten the screws at the base.

Find more information on Expansion Kits at www.jbctools.com.

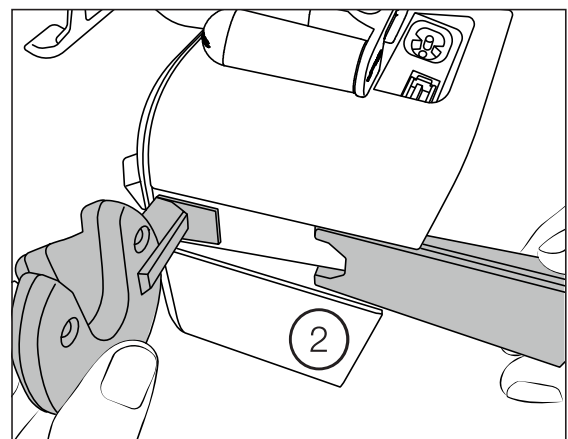
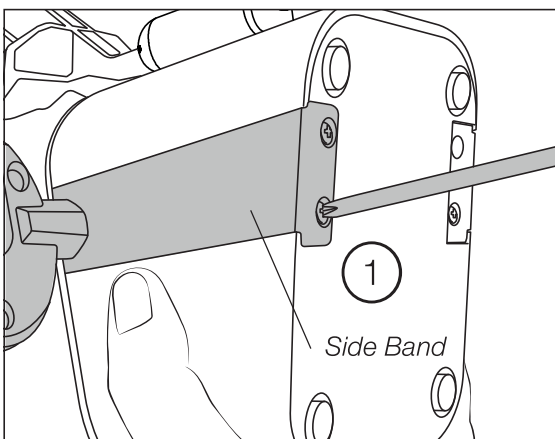

Menu

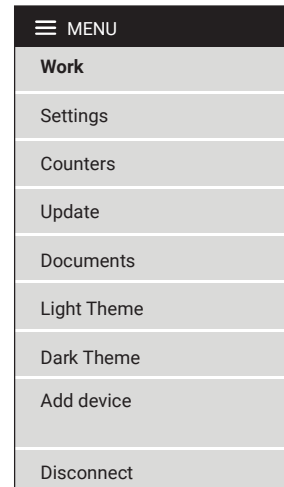
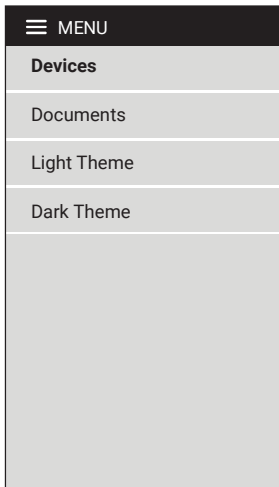

Menu - No Tools Connected

Before any tool has been connected to the station or after the last tool has been disconnected, the menu offers these options.

Menu - Tool Connected

Once at least a tool has been linked, the menu expands and shows some more options.

Work

Takes the user to the work screen (see section “Work Screen”).

Settings

The B-IRON app offers an intuitive user interface, which provides quick access to several station parameters.

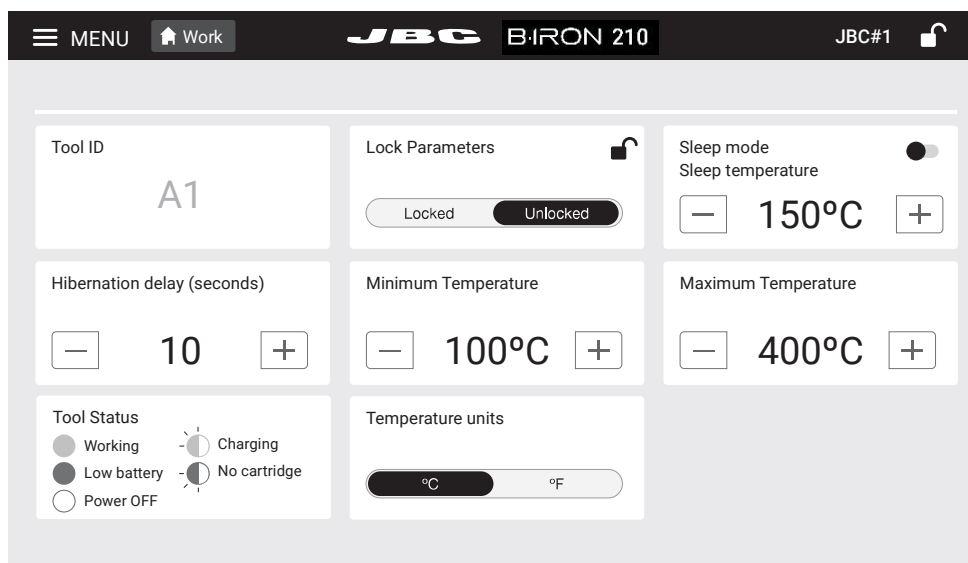

Settings

Parameter	Description
Tool ID	Allows to modify the tool identifier.
Lock parameters	Allows to lock the parameters of the station using a four-digit code. The default code is 0105, but a new code can be set by simply entering some other four digits of choice when locking the parameters.
Sleep Mode / Sleep temperature	Set Sleep Mode on/off. The tip temperature will drop only to the selected Sleep temperature when placed on the tool holder.
Hibernation delay	Set Hibernation delay from 5 to 15 sec. The countdown starts when the tool remains inactive (no movement).
Minimum temperature	Select the minimum temperature that can be set for the Work Mode.
Maximum temperature	Select the maximum temperature that can be set for the Work Mode.
Tool status	The different colors and light modes of the status indicator light mean the following: <ul style="list-style-type: none">- Green: working / soldering- Green blinking: charging- Alternating red/green blinking: low battery, less than 20%- Red blinking: no cartridge- Blue blinkin: tool cap on and tool disconnected from the station- No color: power off
Temperature units	Allows to change the units of temperature measurement between Celsius degrees and Farenheit degrees.

☰ MENU
Work
Settings
Counters
Update
Documents
Light Theme
Dark Theme
Add device
Disconnect

Counters

The Counters section allows the user to consult data and counts on charges, Work Mode periods, Sleep Mode periods, errors... The data can be consulted either by time periods or by number of times a certain event has occurred.

Update

Allows to update the firmware of the soldering station. To know more about the updating process, see section “Updating the Firmware”.

Documents

User manuals related to the station or to the tools can be consulted in this section or on JBC’s website: www.jbctools.com

Light/Dark Theme

Allows the user to switch between dark and light display modes.

Add Device

Connect a second tool to the station.

Disconnect

Disconnect the tool in use. If only one tool is connected, after disconnecting it, the app will return to the device list display.

Installing and Updating the B·IRON App

To install or update the app, some kind of internet connection is required (WiFi, cable, mobile data...).

1. Go to the App Store or Play Store (depending on your operating system).
2. Search for JBC B·IRON on the search bar.
3. Tap on the app and then on *Obtain / Install / Update*.

Alternatively, scan these QR codes to access the B·IRON app page directly:



For Android devices the app installer can also be downloaded from:

<https://www.jbctools.com/jbcsoftware.html>

Updating the Firmware

- Download the JBC update file to your PC from: <https://www.jbctools.com/software.html>.
- Connect the tablet/device via USB connection to the PC.
- Check if there is a folder named “JBC” in the internal storage of the Android device used as B·IRON display. If it doesn’t exist, create it.
- Copy the downloaded file to the JBC folder.
- Access the B·IRON app and, in the Menu, select *Update*.
- Tap on *Select your firmware file* and pick the downloaded file from the drop-down menu.
- Tap on *Update* (1).

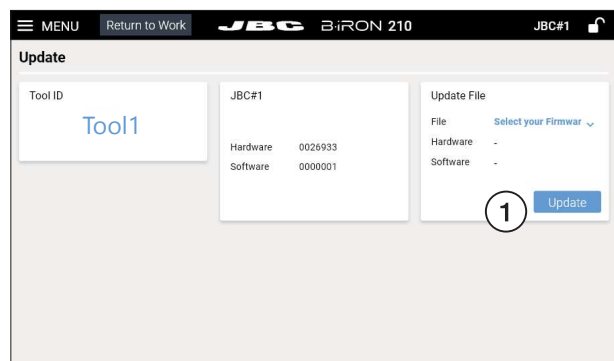

Accessories

B·IRON soldering stations can be accessorized with some additional components specifically designed for them:

Display Holders

JBC offers display holders in two different sizes. Choose the size that best suits your needs and the device you use as display.

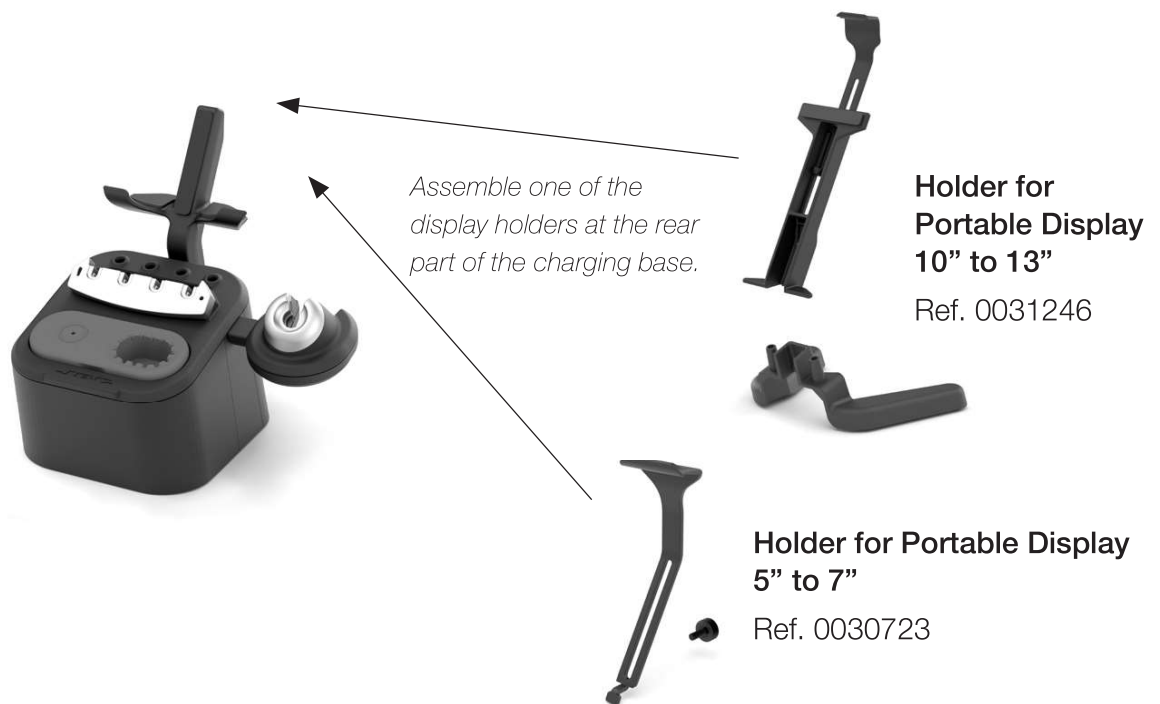

B115

High-Precision Handle for B·IRON

This handle is compatible with B·IRON B210. To store C115 cartridges on the tool holder it is necessary to purchase C115 Cartridge Adapters (ref. **0030643**, sold separately).



BP115K

Expansion Kit for BP115 Tweezers

This kit is fully compatible with B·IRON 210 DUAL. It includes BP115 High-Precision Tweezers with its holder. BP115K is used to expand the versatility of B·IRON soldering stations.



To get more information about the complete B·IRON range visit www.jbctools.com.

Maintenance

Before carrying out maintenance, always extract the cartridge from the tool and disconnect the charging stand from the mains. Allow the equipment to cool down.

- Use a damp cloth to clean the casing and the tool. Alcohol can only be used to clean the metal parts.
- Periodically check that the metal parts of the tool and tool holder are clean so that the charging works properly.
- Maintain the tip surface clean and tinned prior to storage in order to avoid tip oxidation. Rusty and dirty surfaces reduce heat transfer to the solder joint.
- Do not use liquids such as alcohol, thinner or benzene to clean the tablet.
- Repairs should only be performed by a JBC authorized technical service.



Safety



It is imperative to follow safety guidelines to prevent electric shock, injury, fire or explosion.

- Do not use the units for any purpose other than soldering or rework. Incorrect use may cause a fire.
- The power cord must be plugged into approved bases. When unplugging it, hold the plug, not the wire.
- Do not attempt to dismantle or open the housing of the tool as it may cause damage.
- Do not work on electrically live parts.
- The tool should be placed in the stand when not in use in order to charge the batteries.
- The soldering tip or nozzle, the metal part of the tool and the stand may still be hot even when the station is turned off.
- Do not leave the tool unattended when it is on.
- Avoid flux coming into contact with skin or eyes to prevent irritation.
- Be careful with the fumes produced when soldering.
- Keep your workplace clean and tidy. Wear appropriate protection glasses and gloves when working to avoid personal harm.
- Utmost care must be taken with liquid tin waste, which can cause burns.
- This appliance can be used by children over the age of eight and also persons with reduced physical, sensory or mental capabilities or lack of experience provided that they have been given adequate supervision or instruction concerning the use of the appliance and understand the hazards involved. Children must not play with the appliance.
- Maintenance must not be carried out by children unless supervised.
- Do not expose the tablet to high temperatures, humidity or dust. Avoid direct sunlight.
- Do not drop the portable display or the tool, as it may cause damage or malfunction.
- Do not disconnect your device when it is in file transfer mode.
- Do not use the portable display in places where wireless communications are restricted.

Safety - Battery



It is imperative to follow safety guidelines to prevent electric shock, injury, fire or explosion.

- **Caution:** This product contains lithium-ion batteries. Mishandling or improper use may result in fire, explosion, or personal injury.
- Always use the provided charger. Do not use damaged chargers or batteries.
- Never attempt to disassemble or modify the batteries or the product. Doing so may lead to electric shock, fire, or damage to the product.
- In the event of damage, leakage, or overheating of the batteries, discontinue use immediately and contact customer support or JBC technical service facility.
- Dispose of devices with batteries inside, responsibly according to regulations. They must be disposed of in accordance with local regulations so that they can be recycled.
- Do not throw devices with batteries into household waste and do not dispose of them in fire or water.

Specifications

B·IRON 210**Battery-Powered Soldering Station**Ref. **BIS-5A****Charging Base**

- Input: 100 V - 240 V 50/60 Hz
- Nominal Power: 40 W
- Tool Output: 12 V / 1000 mA
- USB Output: 5 V / 1000 mA

B210 Handle

- Peak Power (Tool): 24 W
- Battery: Li-Ion 7.4 V / 750 mAh
- Charge Time: 60 minutes
- Selectable Temperature: 100 - 450 °C / 210 - 840 °F
- Idle Temp. Stability (still air): ± 1.5 °C / ± 3 °F
- Temp. Accuracy: ± 3 % (using reference cartridge)
- Connections: Bluetooth Low Energy (BLE)
- Ambient Operating Temp.: 10 - 50 °C / 50 - 122 °F
- Tool Weight: 75 g / 0.165 lb

Portable Display 7"

- Display Dimensions: 7" / 7 in
- Total Net Weight: 1.75 kg / 3.86 lb
- Total Package Dimensions/Weight:
(L x W x H) 265 x 223 x 160 mm / 2.62 kg
10.43 x 8.78 x 6.30 in / 5.77 lb

Complies with CE standards.

Not grounded device. No ESD discharge feature.

JBC

Warranty

JBC's 2 year warranty covers this equipment against all manufacturing defects, including the replacement of defective parts and labour.

Warranty does not cover product wear or misuse.

In order for the warranty to be valid, equipment must be returned, postage paid, to the dealer where it was purchased.

Get 1 extra year JBC warranty by registering here:

<https://www.jbctools.com/productregistration/>

within 30 days of purchase.



This product should not be thrown in the garbage.

In accordance with the European directive 2012/19/EU, electronic equipment at the end of its life must be collected and returned to an authorized recycling facility.

**CE EAC UK
CA**

www.jbctools.com