

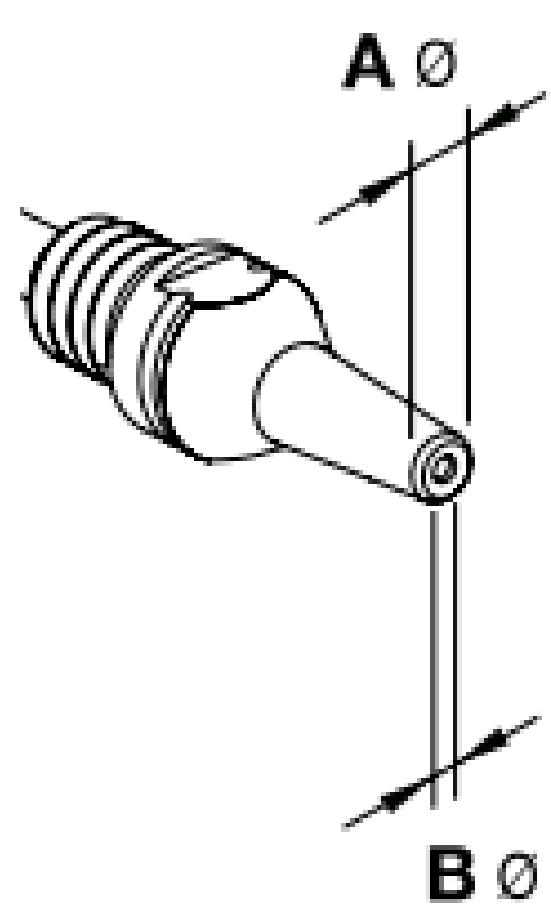

D530 Cartridge Range

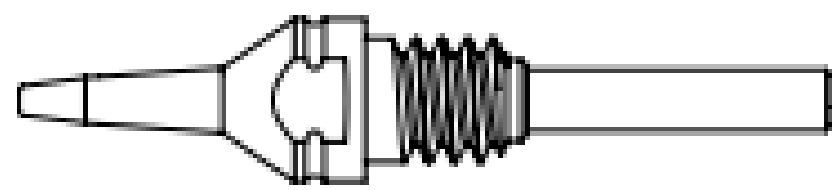

Through-hole desoldering



D530001
 A = \varnothing 1.4 (\varnothing 0.055)
 B = \varnothing 0.6 (\varnothing 0.024)
 max. pin = \varnothing 0.4 (\varnothing 0.016)

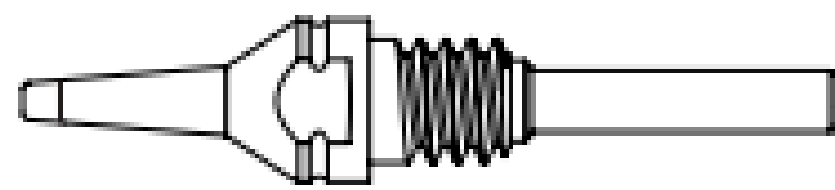

D530002
 A = \varnothing 1.8 (\varnothing 0.071)
 B = \varnothing 0.8 (\varnothing 0.032)
 max. pin = \varnothing 0.6 (\varnothing 0.024)

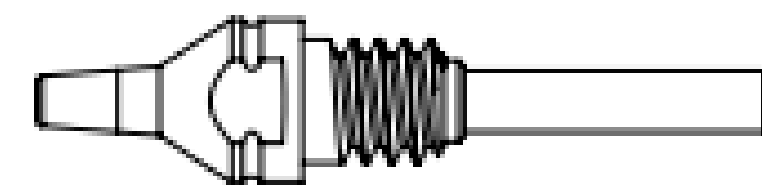

D530014
 A = \varnothing 2.5 (\varnothing 0.098)
 B = \varnothing 0.8 (\varnothing 0.032)
 max. pin = \varnothing 0.6 (\varnothing 0.024)

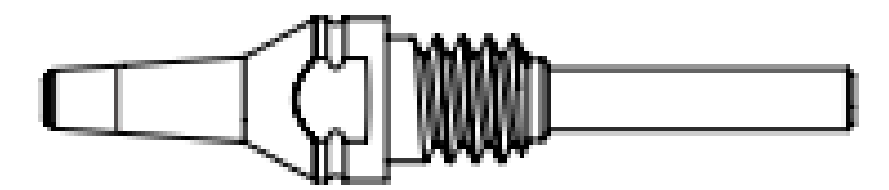

D530003
 A = \varnothing 2.7 (\varnothing 0.106)
 B = \varnothing 1 (\varnothing 0.039)
 max. pin = \varnothing 0.8 (\varnothing 0.032)

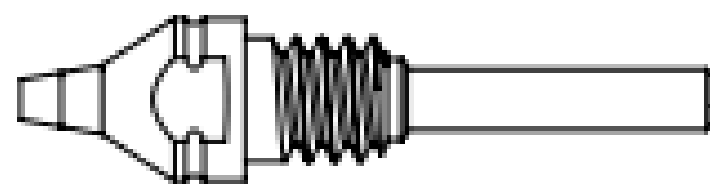

D530017
 A = \varnothing 2 (\varnothing 0.079)
 B = \varnothing 1.1 (\varnothing 0.043)
 max. pin = \varnothing 1 (\varnothing 0.039)

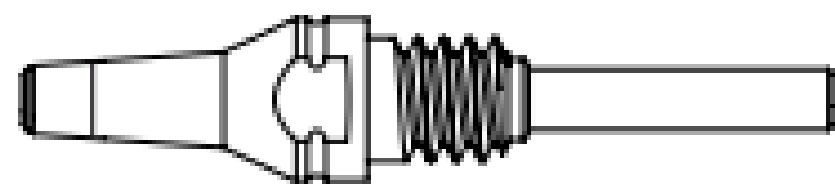

D530004
 A = \varnothing 3.2 (\varnothing 0.126)
 B = \varnothing 1.3 (\varnothing 0.052)
 max. pin = \varnothing 1.1 (\varnothing 0.043)

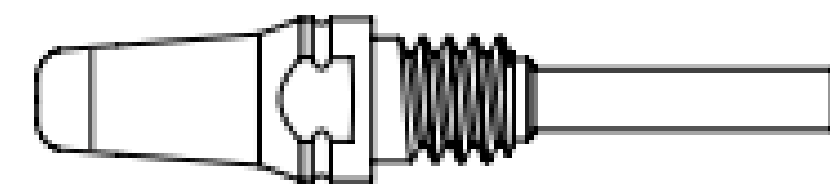

D530009
 A = \varnothing 5 (\varnothing 0.197)
 B = \varnothing 1.3 (\varnothing 0.052)
 max. pin = \varnothing 1.1 (\varnothing 0.043)

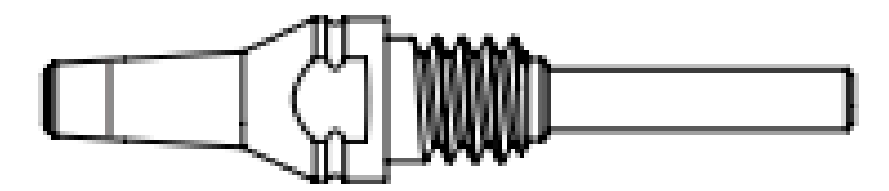

D530005
 A = \varnothing 3.4 (\varnothing 0.134)
 B = \varnothing 1.5 (\varnothing 0.059)
 max. pin = \varnothing 1.3 (\varnothing 0.051)

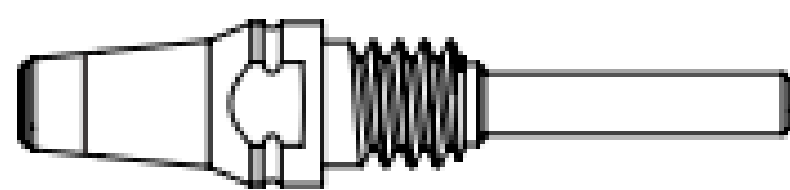

D530006
 A = \varnothing 4.2 (\varnothing 0.165)
 B = \varnothing 1.9 (\varnothing 0.075)
 max. pin = \varnothing 1.7 (\varnothing 0.067)

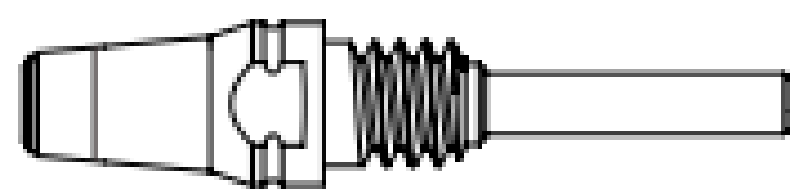

D530018
 A = \varnothing 4.6 (\varnothing 0.181)
 B = \varnothing 2.2 (\varnothing 0.087)
 max. pin = \varnothing 2 (\varnothing 0.079)

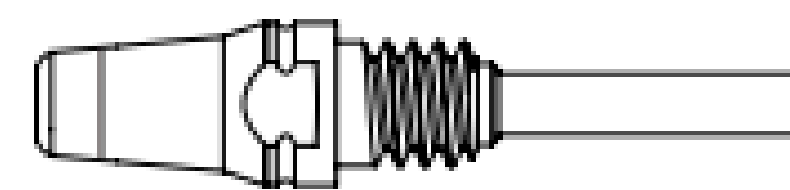

D530007
 A = \varnothing 4.8 (\varnothing 0.189)
 B = \varnothing 2.4 (\varnothing 0.095)
 max. pin = \varnothing 2.2 (\varnothing 0.087)

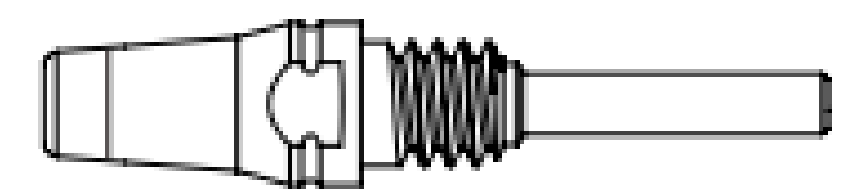

D530015
 A = \varnothing 5.2 (\varnothing 0.205)
 B = \varnothing 3 (\varnothing 0.118)
 max. pin = \varnothing 2.8 (\varnothing 0.110)

Pad cleaning

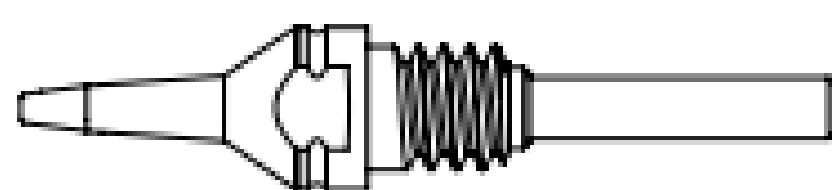

D530011
 A = \varnothing 1.4 (\varnothing 0.055)
 B = \varnothing 0.6 (\varnothing 0.024)

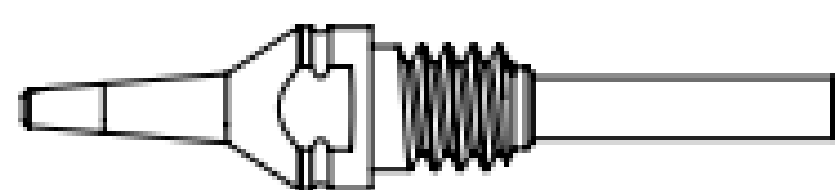

D530012
 A = \varnothing 1.8 (\varnothing 0.071)
 B = \varnothing 0.8 (\varnothing 0.032)

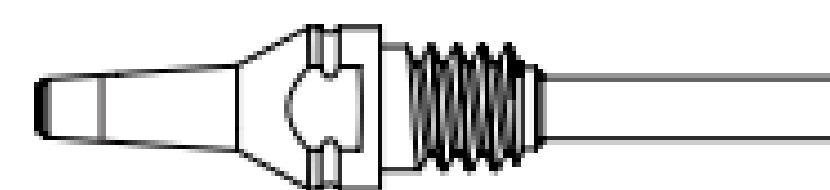

D530013
 A = \varnothing 2.7 (\varnothing 0.106)
 B = \varnothing 1 (\varnothing 0.039)

millimeters / (inches)